



# Specification

## SSC-GR202

**(Rev 1.0, General)**

SSC		Customer
Drawn	Approval	Approval

# [ Contents ]

1. Absolute maximum ratings
2. Electro-optical characteristics
3. Characteristic diagram
4. Soldering profile
5. Outline dimension
6. Packing
7. Reel packing structure
8. Precaution for use

# SSC-GR202

## SSC-GR202

### Description

- Small size suitable for compact appliances
- Surface-mounted and leadless chip LED device
- High brightness, wide variety of colors are available
- Tape and Reel packing
- Increases the life time of battery



### Features

- 3.0 X 1.5 X 1.4 mm
- Inner Lens type, Clear mold
- Wavelength : 570 nm

### Applications

- Decoration lighting

SSC-GR202

Revision 1.0

[www.ZLED.com](http://www.ZLED.com)

## 1. Absolute maximum ratings

(Ta=25 )

Parameter	Symbol	Value	Unit
Power Dissipation	$P_d$	75	mW
Forward Current	$I_F$	30	mA
Peak Forward Current	$I_{FM}^{*1}$	50	mA
Reverse Voltage	$V_R$	5	V
Operation Temperature	$T_{opr.}$	-30 ~ 85	
Storage Temperature	$T_{stg.}$	-40 ~ 100	

\*1  $I_{FM}$  conditions: Pulse width  $T_w$  0.1ms and Duty ratio 1/10

## 2. Electro-Optical Characteristics

(Ta=25 )

Parameter	Symbol	Condition	Min	Typ	Max	Unit
Forward Voltage	$V_F$	$I_F=20$ mA	1.8	2.1	2.5	V
Reverse Current	$I_R$	$V_R=5$ V	-	-	10	$\mu$ A
Luminous Intensity*2	$I_V$	$I_F=20$ mA	35	-	60	mcd
Wavelength	$\lambda$	$I_F=20$ mA	568	570	574	nm
Spectral Bandwidth		$I_F=20$ mA		20		nm
Viewing Angle*3	$2_{1/2}$	$I_F=20$ mA		70		$^{\circ}$

\*2 The luminous intensity  $I_V$  is measured at the peak of the spatial pattern which may not be aligned with the mechanical axis of the LED package.

\*3  $_{1/2}$  is the off-axis where the luminous intensity is 1/2 the peak intensity.

[Note] All products conform to the listed minimum and maximum specifications for electric and optical characteristics, when operated at 20mA within the maximum ratings shown above. All measurements were made under the standardized environment of SSC.

(Tolerance :  $I_V \pm 10\%$ ,  $\lambda \pm 2$  nm,  $V_F \pm 0.1$  V)

### 3. Characteristic Diagram

**Forward Current vs Forward Voltage**

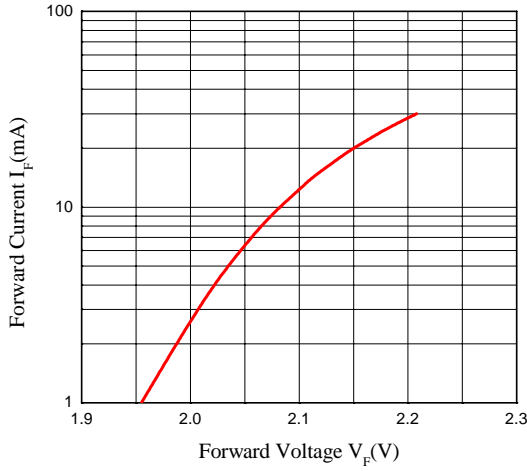

**Relative Intensity vs Forward Current**

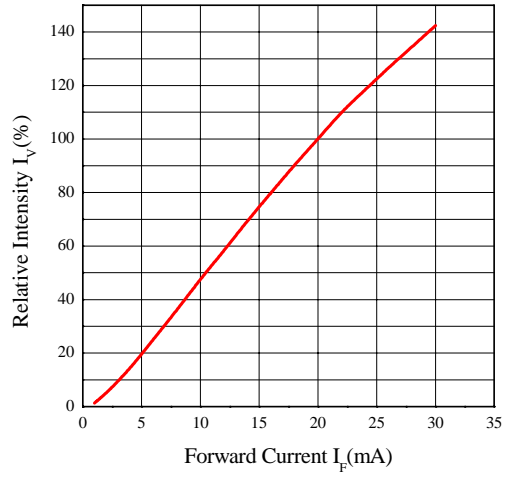

**Forward Current vs Derating Curve**

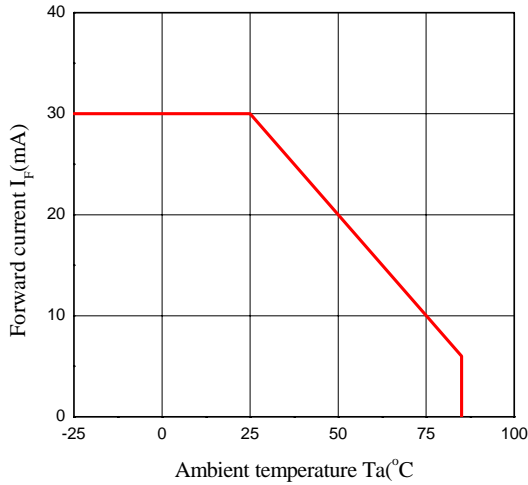

**Radiation Diagram**

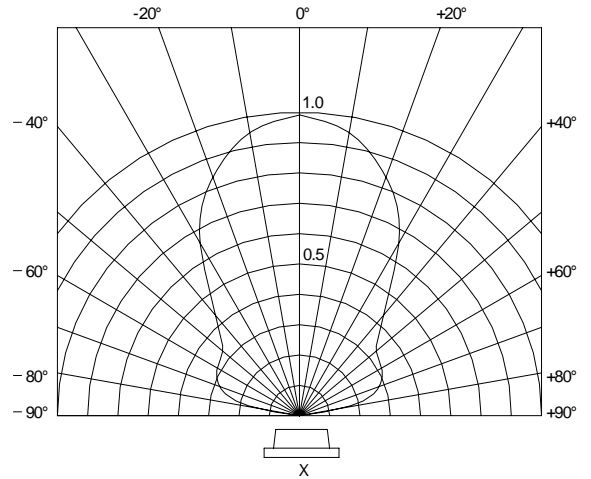

## 4. Soldering profile

### Reflow Soldering Conditions/ Profile

#### (1) Lead Solder

- Preliminary heating to be at 150 °C max. for 2 minutes max.
- Soldering heat to be at 240 °C max. for 5 seconds max.

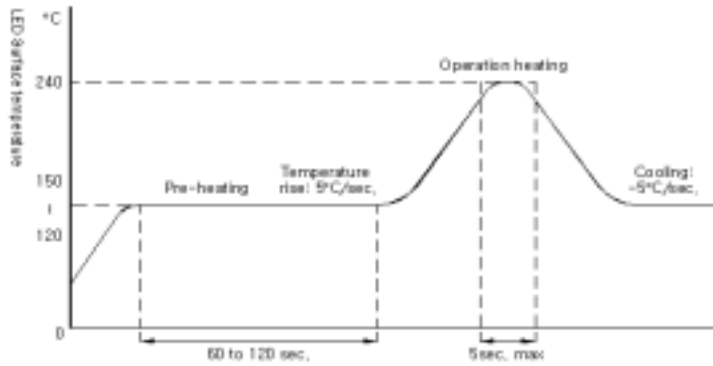

#### (2) Lead-Free Solder

- Preliminary heating to be at 150 °C max. for 2 minutes max.
- Soldering heat to be at 260 °C max. for 10 seconds max.

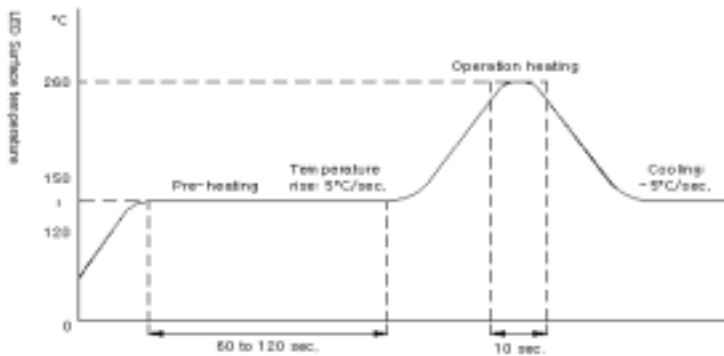

#### (3) Hand Soldering Condition

- Not more than 3 seconds @MAX280 °C, under Soldering iron.

[Note] In case the soldered products are reused in soldering process, we don't guarantee the products.

### 5. Outline Dimension

Tolerance:  $\pm 0.1$ , Unit: mm

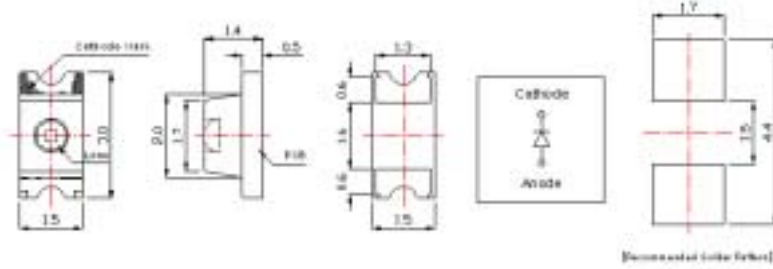

### 6. Packing

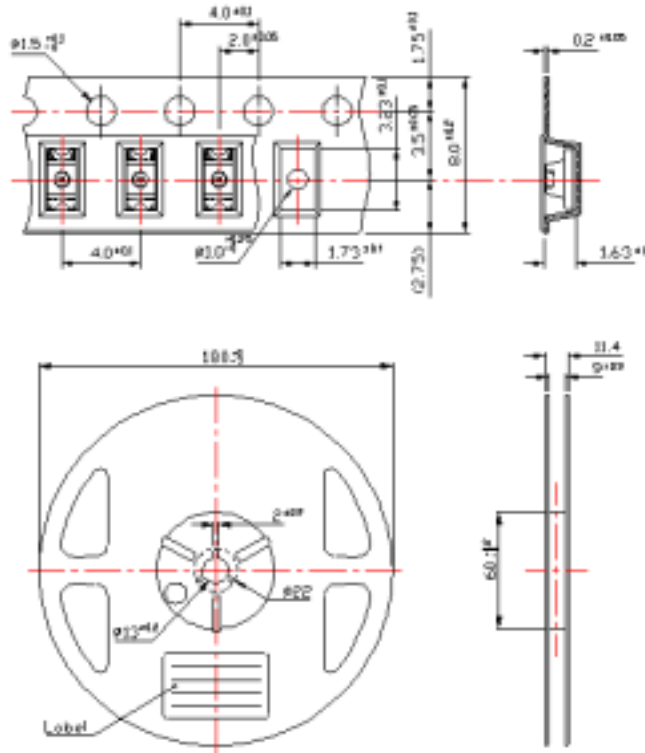

Tolerance:  $\pm 0.2$ , Unit: mm

- (1) Quantity: 3,000pcs./Reel
- (2) Cumulative Tolerance: Cumulative Tolerance/10pitches to be  $\pm 0.2$ mm
- (3) Adhesion Strength of Cover Tape: Adhesion strength to be 0.1-0.7N when the over tape is turned off from the carrier tape at  $10^\circ$  angle to be the carrier tape.
- (4) Package: P/N, Manufacturing data Code No. and quantity to be indicated on a damp proof Package.

## 7. Reel Packing Structure

### Reel

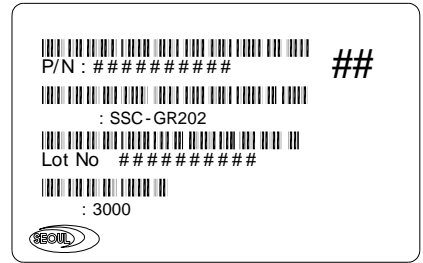
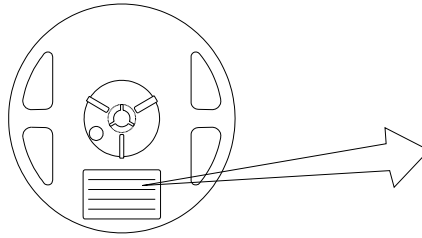

### Aluminum Vinyl Bag

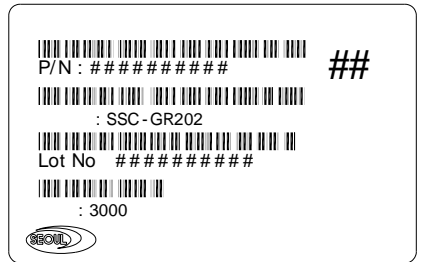
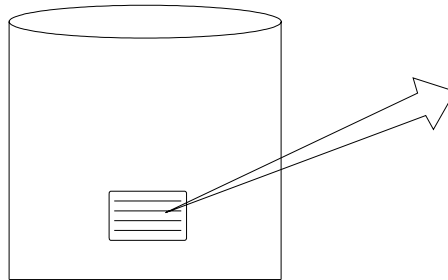

### Outer Box

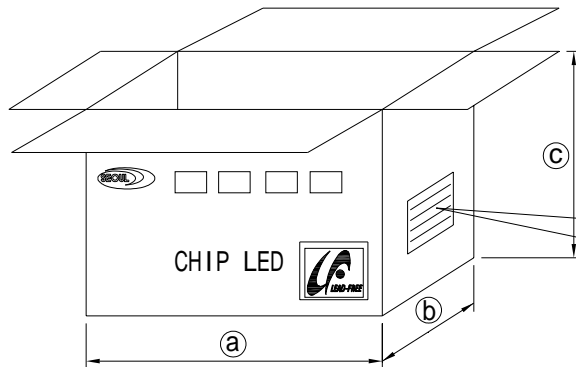

\*Material: Paper(SW3B(B))

TYPE	SIZE(mm)		
	a	b	c
7inch	245	220	142

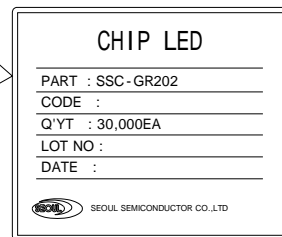



## 8. Precaution for Use

### (1) Storage

In order to avoid the absorption of moisture, it is recommended to store in the dry box (or desiccator) with a desiccant. Otherwise, to store them in the following environment is recommended.

Temperature : 5 ~30      Humidity : 60%HR max.

### (2) Attention after opened

However LED is corresponded SMD, when LED be soldered dip, interfacial separation may affect the light transmission efficiency, causing the light intensity to drop. Attention in followed.

a. After opened and mounted, the soldering shall be quickly.

b. Keeping of a fraction

Temperature : 5 ~ 40      Humidity : less than 30%

(3) In case of more than 1 week passed after opening or change color of indicator on desiccant components shall be dried 10-12hr. at  $60\pm 5$  .

(4) In case of supposed the components is humid, shall be dried dip-solder just before.

100Hr at  $80\pm 5$     or 12Hr at  $100\pm 5$  .

(5) Any mechanical force or any excess vibration shall not be accepted to apply during cooling process to normal temp. after soldering.

(6) Quick cooling shall not be avoid.

(7) Components shall not be mounted on warped direction of PCB.

(8) Anti radioactive ray design is not considered for the products listed here in.

(9) Gallium arsenide is used in some of the products listed in this publication. These products are dangerous if they are burned or smashed in the process of disposal. It is also dangerous to drink the liquid or inhale the gas generated by such products when chemically disposed.

(10) This device should not be used in any type of fluid such as water, oil, organic solvent and etc. When washing is required, IPA should be used.

(11) When the LEDs are illuminating, operating current should be decided after considering the ambient maximum temperature.

(12) LEDs must be stored to maintain a clean atmosphere. If the LEDs are stored for 3 months or more after being shipped from SSC, a sealed container with a nitrogen atmosphere should be used for storage.

(13) The LEDs must be soldered within seven days after opening the moisture-proof packing.

(14) Repack unused products with anti-moisture packing, fold to close any opening and then store in a dry place.

(15) The appearance and specifications of the product may be modified for improvement without notice.